

### PROFESSIONAL KITCHEN LINE Single Bowl Undermount

Model MR2918S

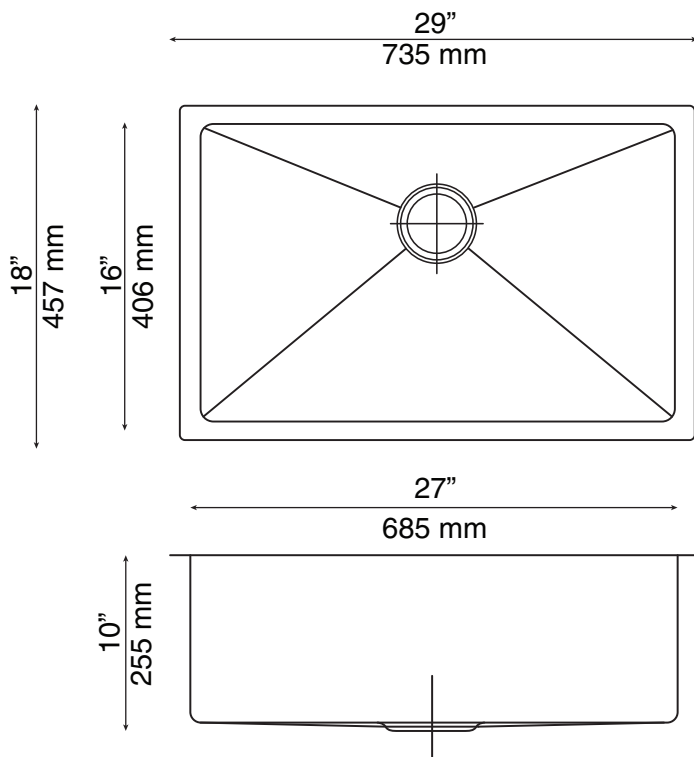

#### What sets MoSER sinks apart

- » Hand crafted modern European design
- » Professional quality stainless steel – 16 gauge
- » Corrosion resistant – 304 stainless steel
- » Single bowl sink with 15mm corners
- » Stone Guard undercoating over rubber pad for superior sound dampening
- » Supplied with template and strainer
- » 100% recyclable
- » cUPC certified

#### Technical Specifications

- » Outside dimensions: 29" x 18" x 10"
- » Inside dimensions: 27" x 16" x 10"
- » 3 ½" drain opening
- » Minimum Cabinet Size: 31"

#### Warranty

Every MoSER sink comes with a limited lifetime warranty. For more details please refer to our product warranty section on our website.

MoSER makes all efforts to provide accurate information, all dimensions are nominal, cannot be guaranteed and are subject to change or cancellation. MoSER assumes no responsibility for the use of superseded voided specifications.

